

# Photons and sensors

(with an interlude on the history of color photography)

CS 178, Spring 2012

---



Marc Levoy  
Computer Science Department  
Stanford University

# Camera pixel pipeline

---

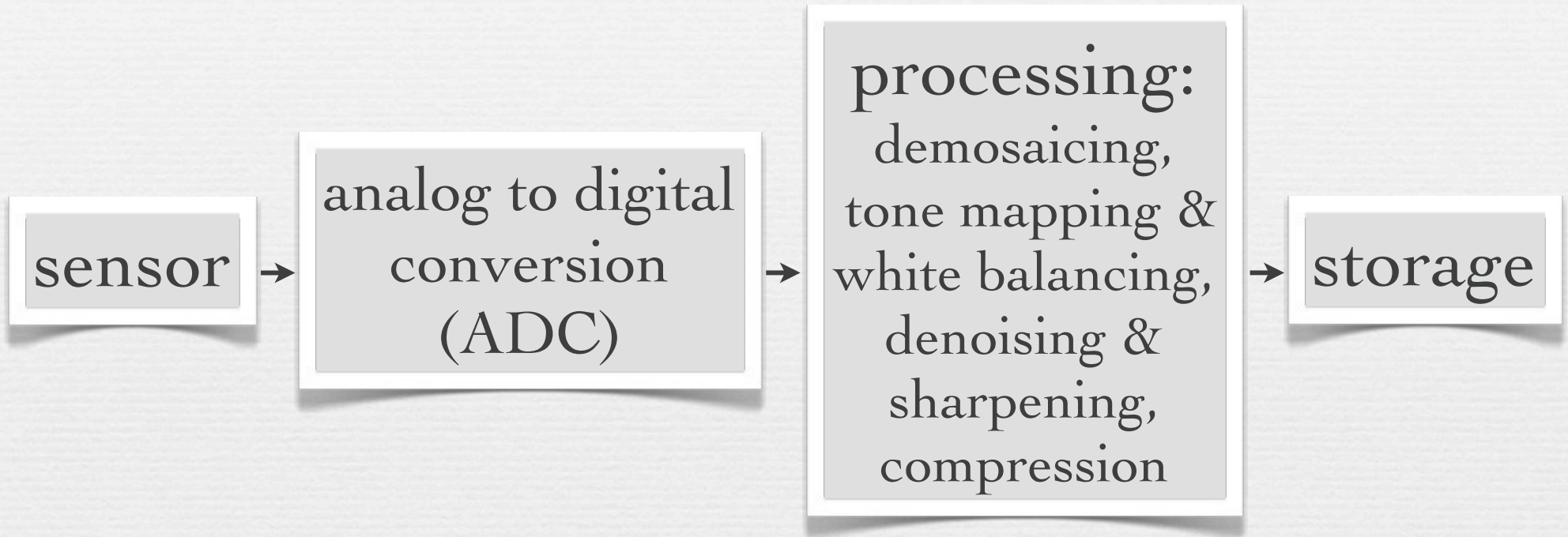

- ◆ every camera uses different algorithms
- ◆ the processing order may vary
- ◆ most of it is proprietary

# Example pipeline

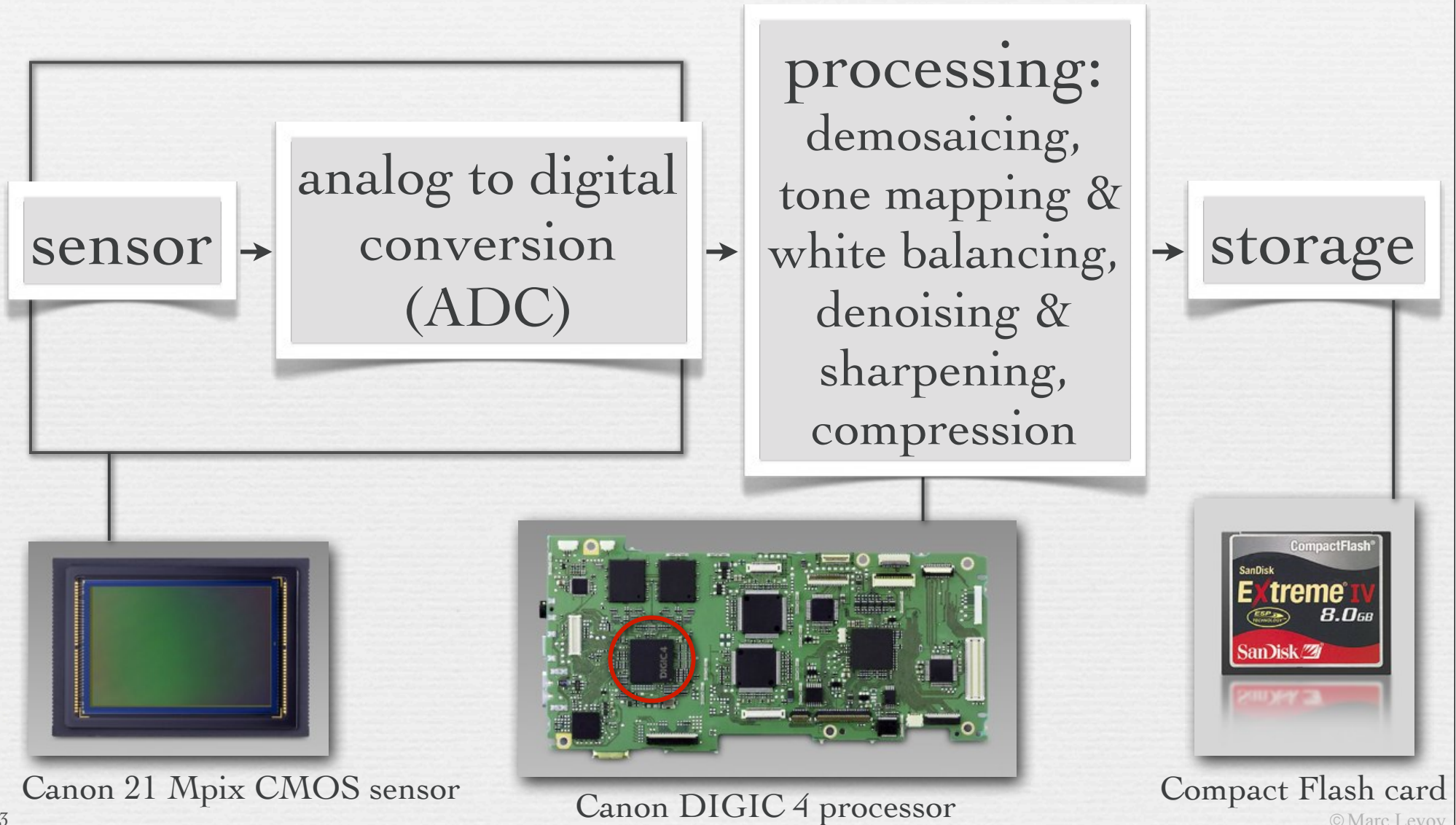



# Example

(parts are from a Canon 5DII, but cutaway view is of 1DIII)

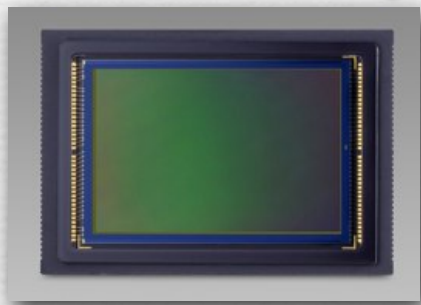
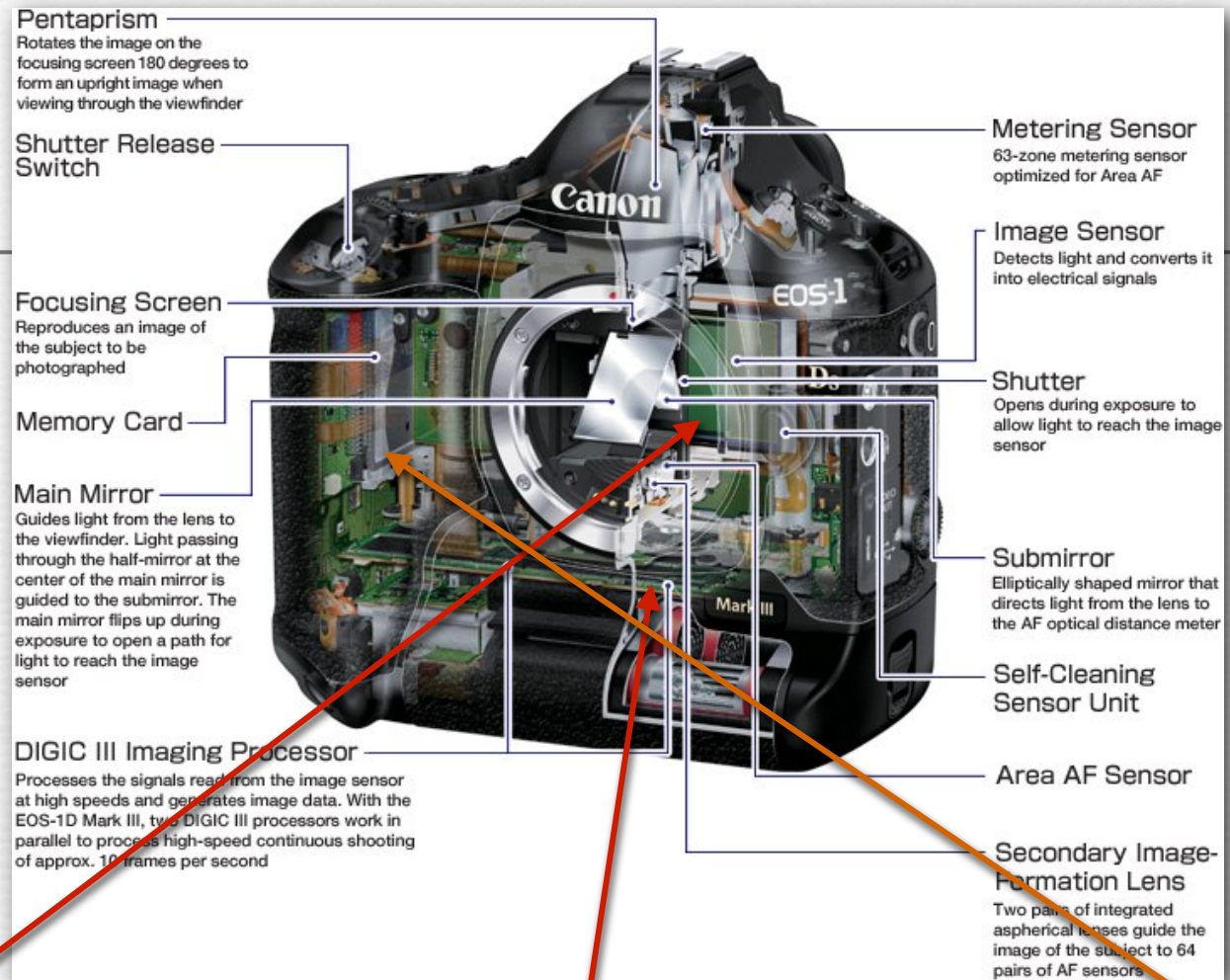

Canon 21 Mpix CMOS sensor

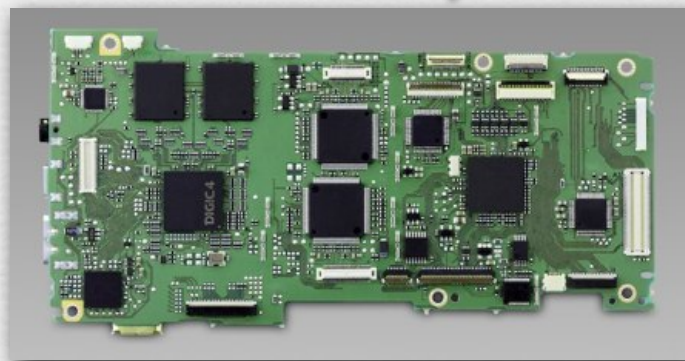

Canon DIGIC 4 processor



Compact Flash card



# Outline

---

- ◆ converting photons to charge
- ◆ getting the charge off the sensor
  - CCD versus CMOS
  - analog to digital conversion (ADC)
- ◆ supporting technology
  - microlenses
  - antialiasing filters
- ◆ sensing color

# The photoelectric effect

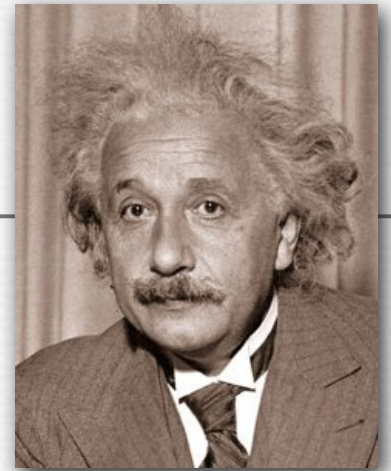

Albert Einstein

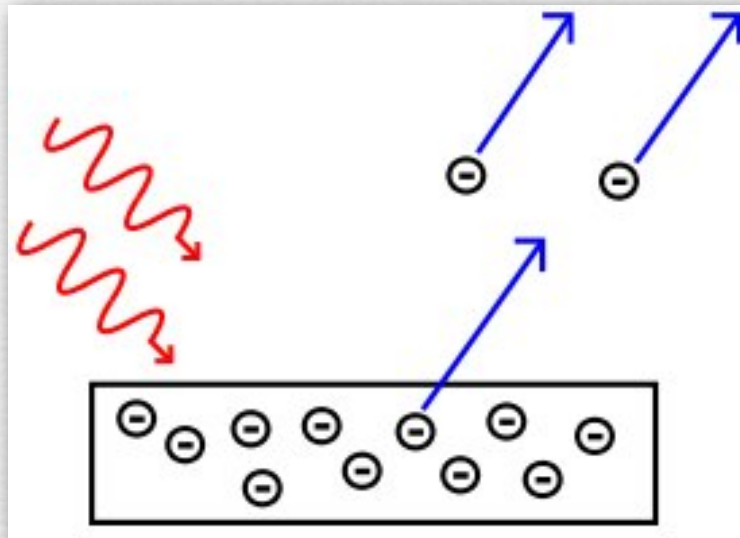

(wikipedia)

- ◆ when a photon strikes a material, an electron may be emitted
  - depends on the photon's energy, which depends on its wavelength

$$E_{\text{photon}} = \frac{h \times c}{\lambda}$$

- there is no notion of “brighter photons”, only more or fewer of them



# Quantum efficiency

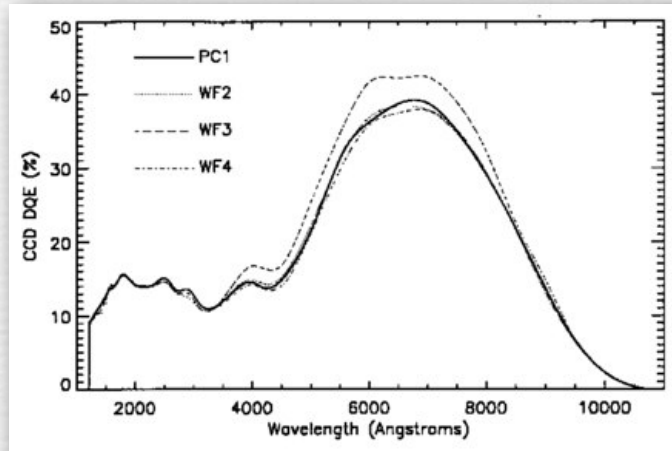

Hubble Space Telescope Camera 2

the iPhone 4S uses a back-illuminated CMOS sensor

- ◆ not all photons will produce an electron
  - depends on quantum efficiency of the device

$$QE = \frac{\# \text{ electrons}}{\# \text{ photons}}$$

- human vision: ~15%
- typical digital camera: < 50%
- best back-thinned CCD: > 90%

back-illuminated CMOS (Sony)

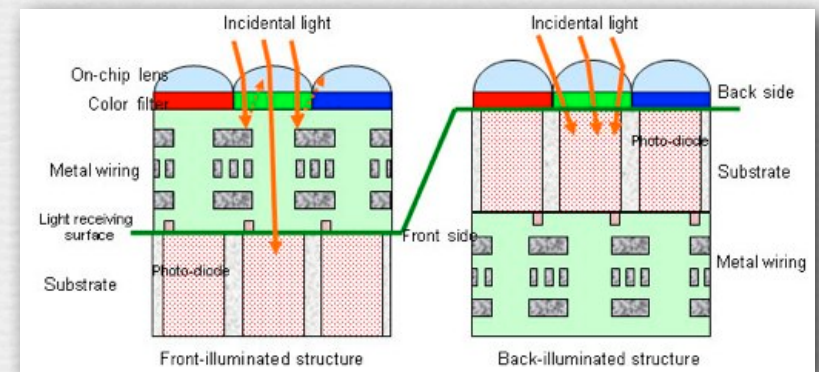

# Pixel size

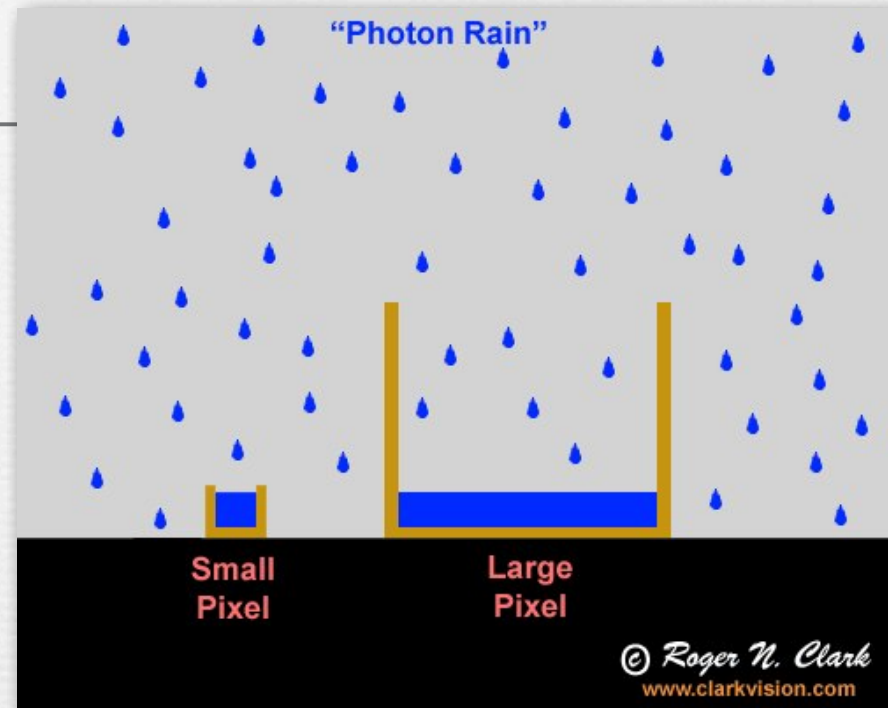

- ◆ the current from one electron is small (10-100 fA)
  - so integrate over space and time (pixel area  $\times$  exposure time)
  - larger pixel  $\times$  longer exposure means more accurate measure
- ◆ typical pixel sizes
  - casio EX-F1:  $2.5\mu \times 2.5\mu = 6\mu^2$
  - Canon 5D II:  $6.4\mu \times 6.4\mu = 41\mu^2$



# Full well capacity

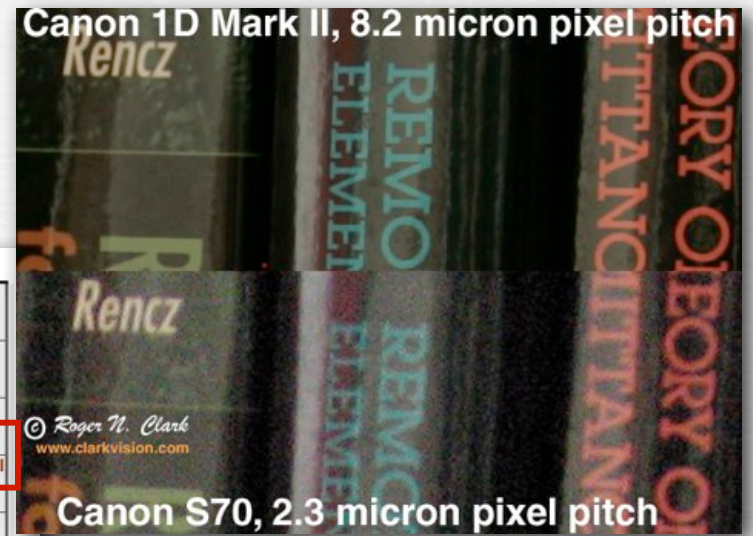
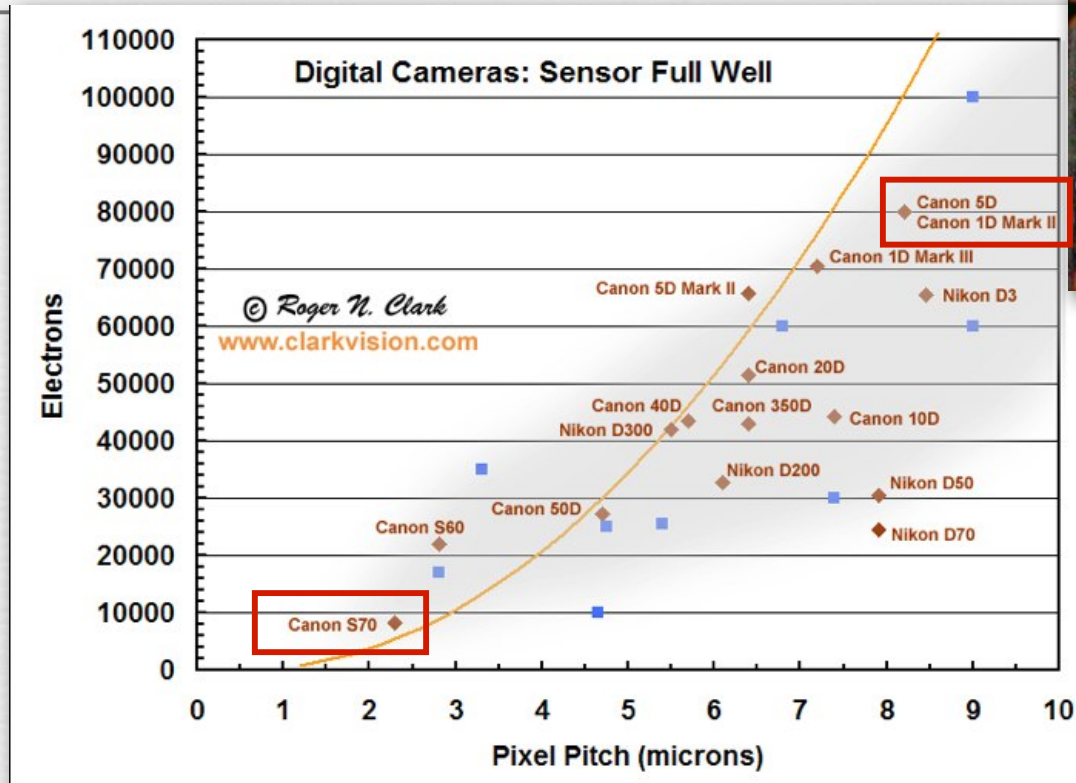

(clarkvision.com)

- ◆ how many electrons can a pixel hold?
  - depends mainly on the size of the pixel (but fill factor is important)
- ◆ too many photons causes *saturation*
  - larger capacity leads to higher *dynamic range* between the brightest scene feature that won't saturate and the darkest that isn't too noisy

# Blooming

---



(ccd-sensor.de)

- ◆ charge spilling over to nearby pixels
  - can happen on CCD and CMOS sensors
  - don't confuse with glare or other image artifacts



# Image artifacts can be hard to diagnose

---



([http://farm3.static.flickr.com/2102/2248725961\\_540be5f9af.jpg?v=0](http://farm3.static.flickr.com/2102/2248725961_540be5f9af.jpg?v=0))

Q. Is this blooming?

# Explanation of preceding image (contents of whiteboard)

---

- ◆ there may be blooming in the sky, but the shrinkage of the horse's leg can be explained purely as a byproduct of misfocus
  - in the accompanying plan view diagram, the horse's leg is shown at top (in cross section)
  - the solid bundle of rays, corresponding to one sensor pixel, crossed before the leg (was misfocused), then spread out again, but saw only more leg, so its color would be dark
  - the dashed bundle of rays, corresponding to a nearby pixel, crossed at the same depth but to the side of the solid bundle, then spread out again, seeing partly leg and partly sky; its color would be lighter than the leg
  - this lightening would look like the sky was "blooming" across the leg, but it's just a natural effect produced by misfocus

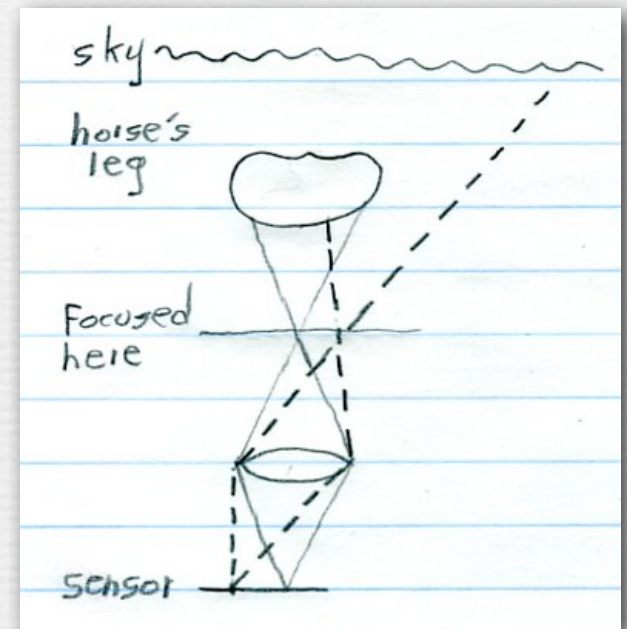



# CMOS versus CCD sensors

CMOS

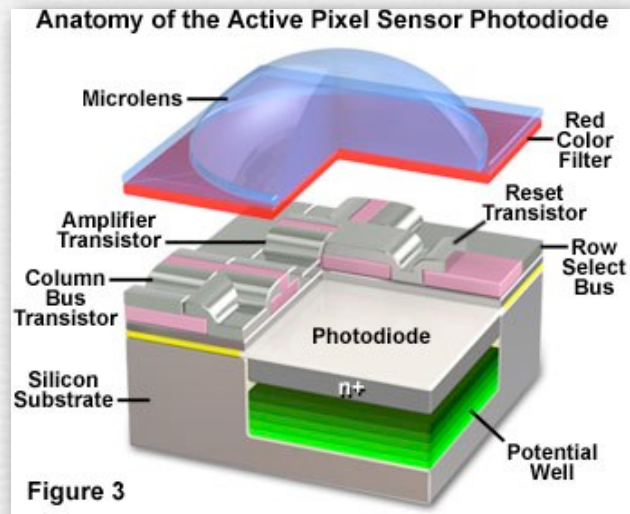

CCD

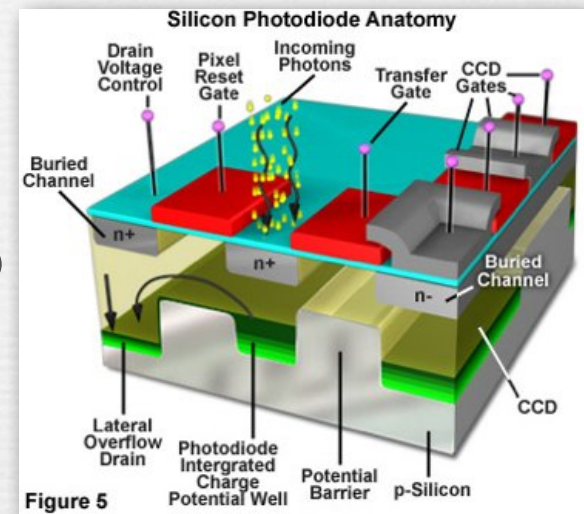

◆ CMOS = complementary metal-oxide semiconductor

- an amplifier per pixel converts charge to voltage
- low power, but noisy (but getting better)

◆ CCD = charge-coupled device

Nikon D40

Canon SLRs

- charge shifted along columns to an output amplifier
- oldest solid-state image sensor technology
- highest image quality, but not as flexible or cheap as CMOS

# Gratuitous animation showing a CCD “bucket brigade” readout

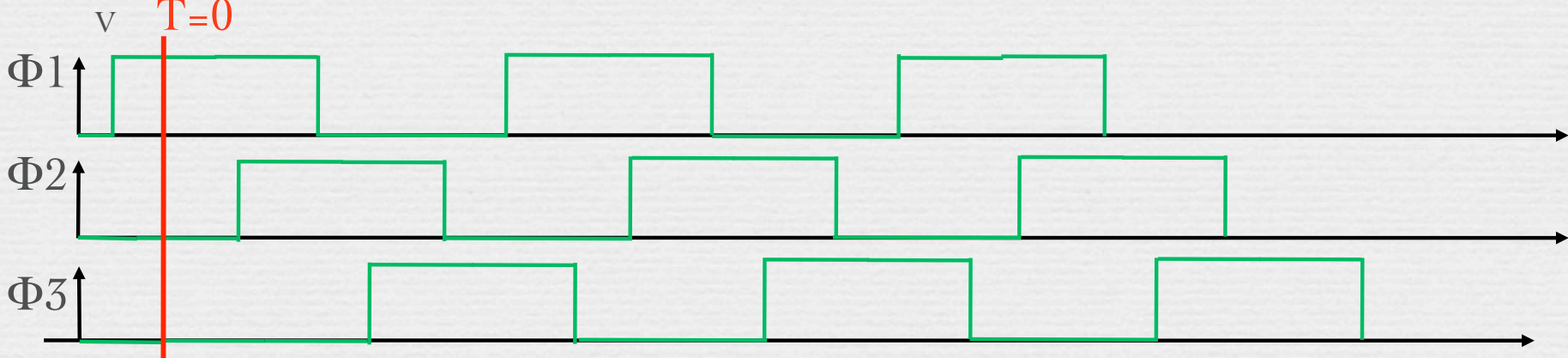
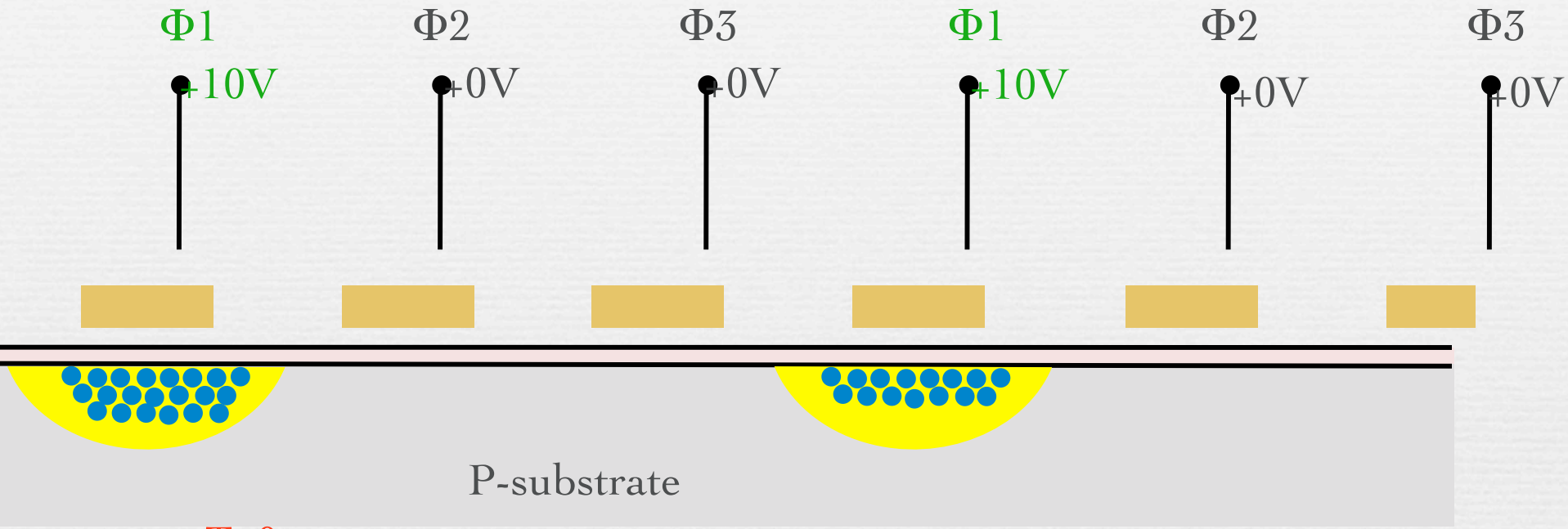



# Gratuitous animation showing a CCD “bucket brigade” readout

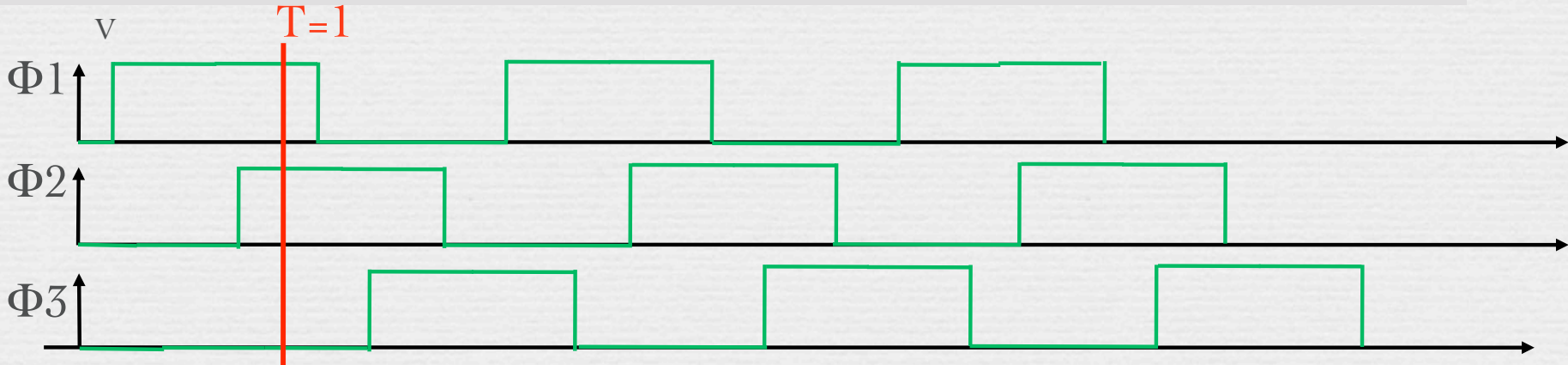
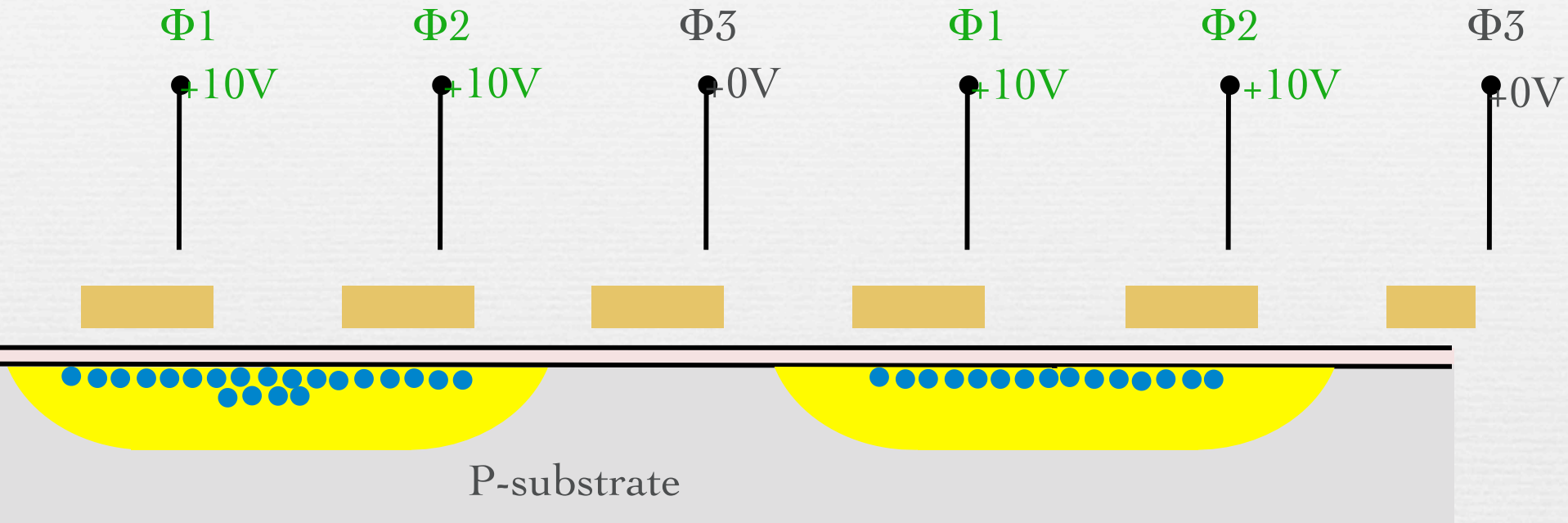

# Gratuitous animation showing a CCD “bucket brigade” readout

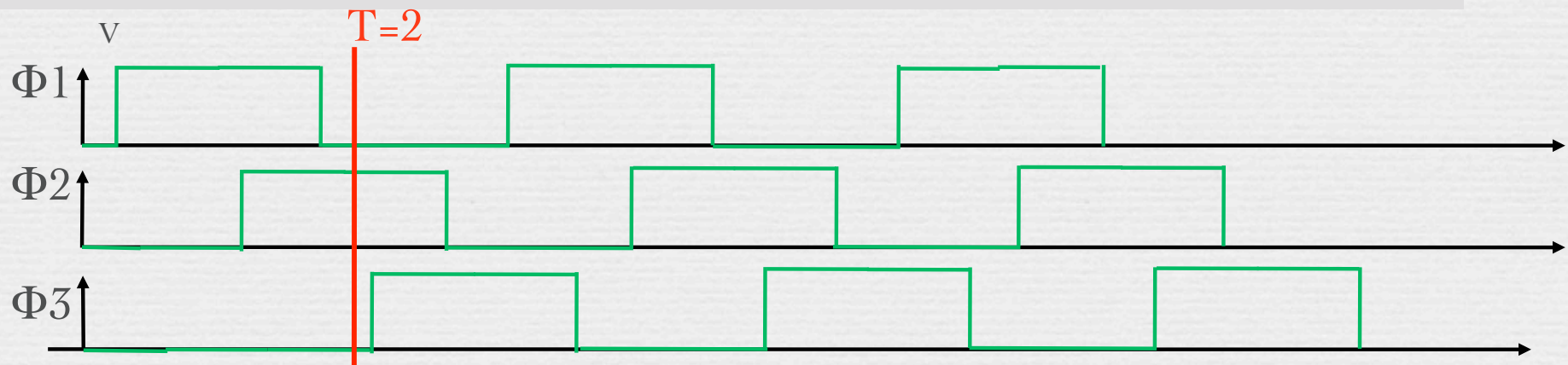
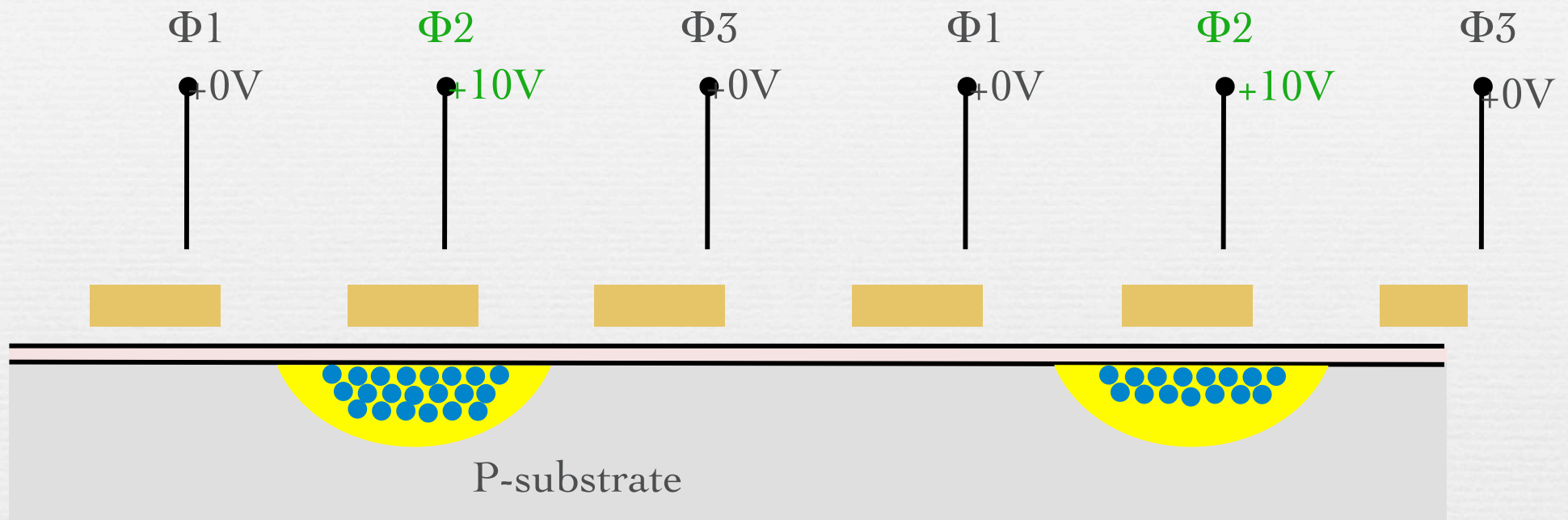



# Gratuitous animation showing a CCD “bucket brigade” readout

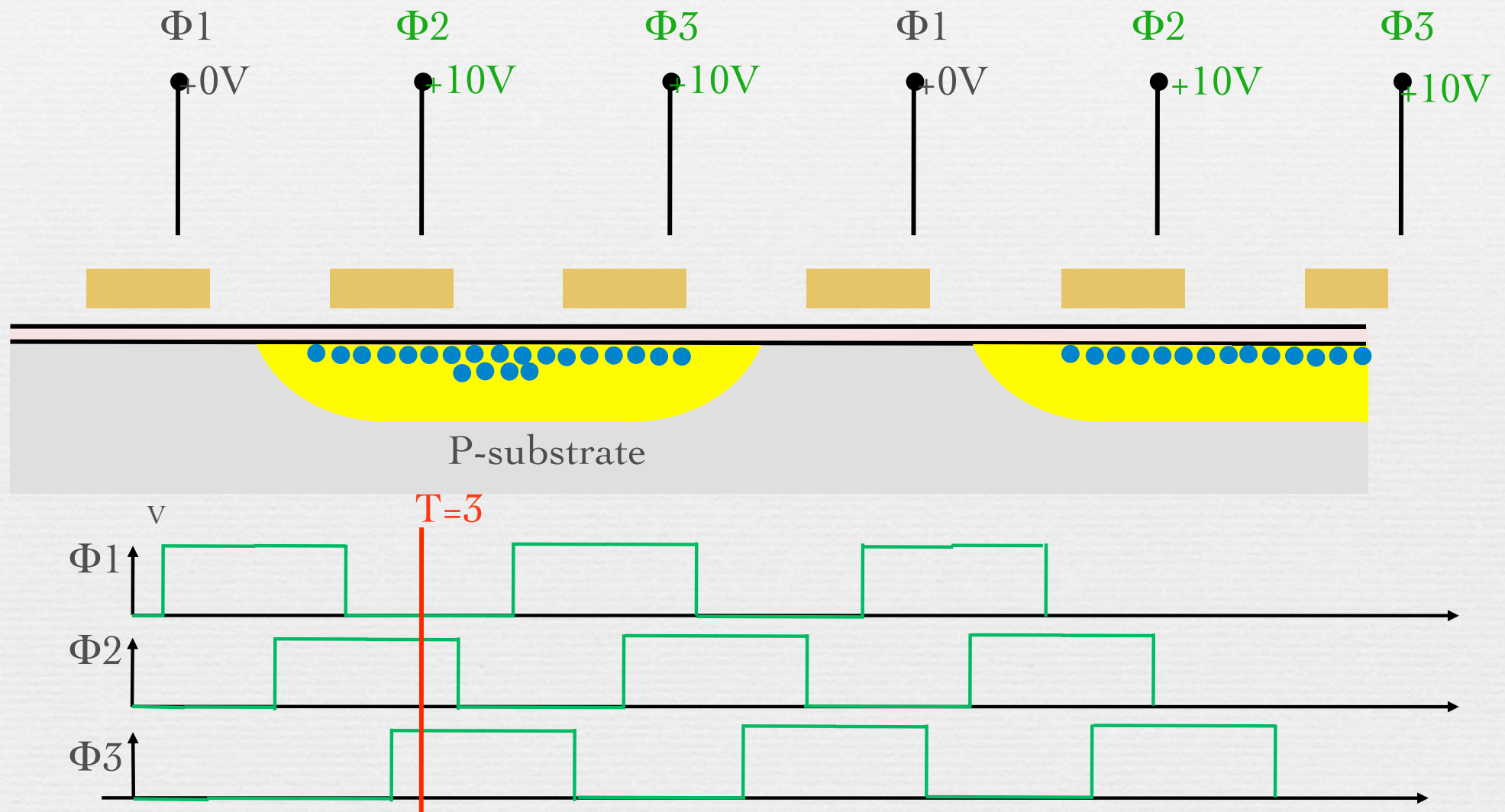

# Gratuitous animation showing a CCD “bucket brigade” readout

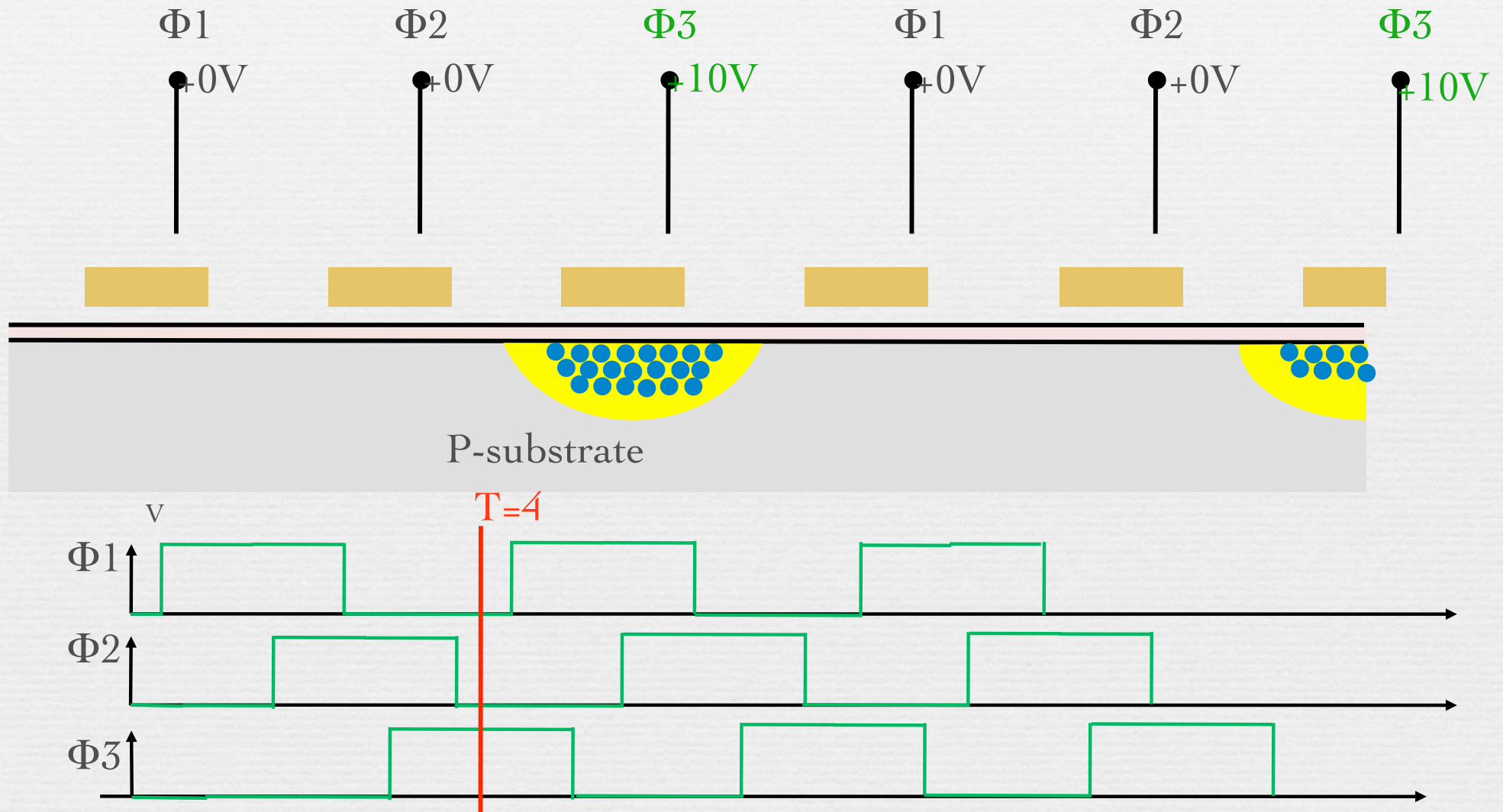



# Gratuitous animation showing a CCD “bucket brigade” readout

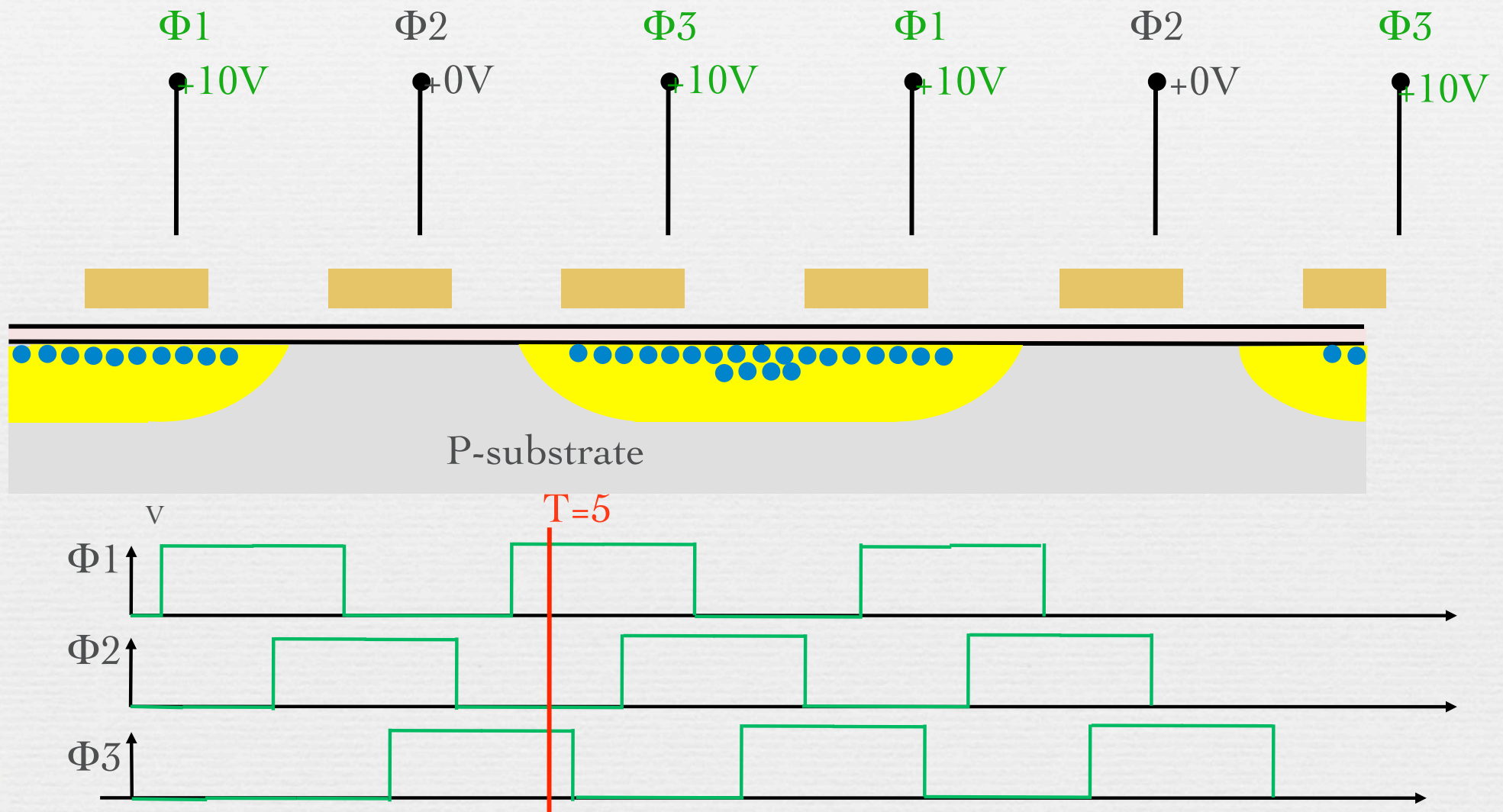

# Smearing

(dvxuser.com)

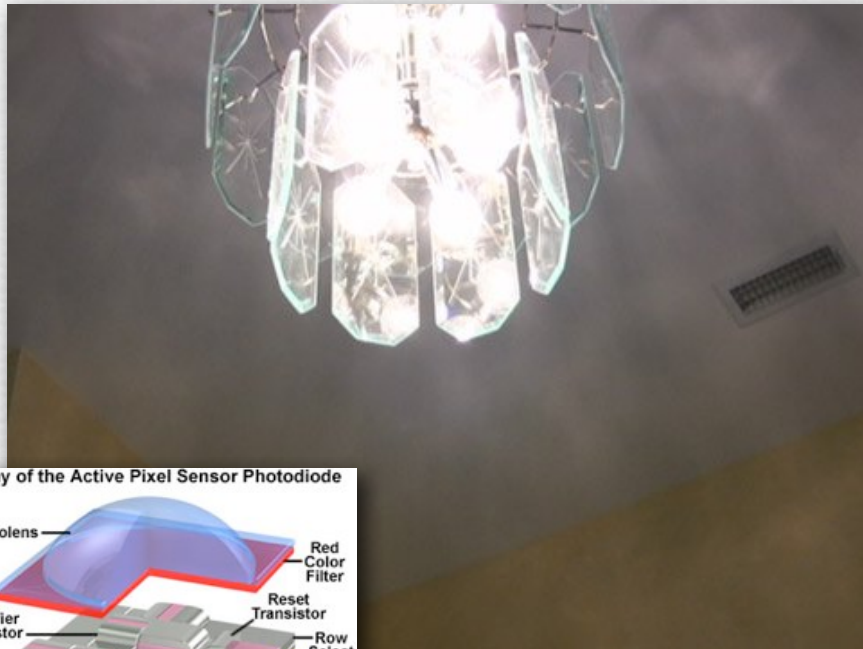

CMOS

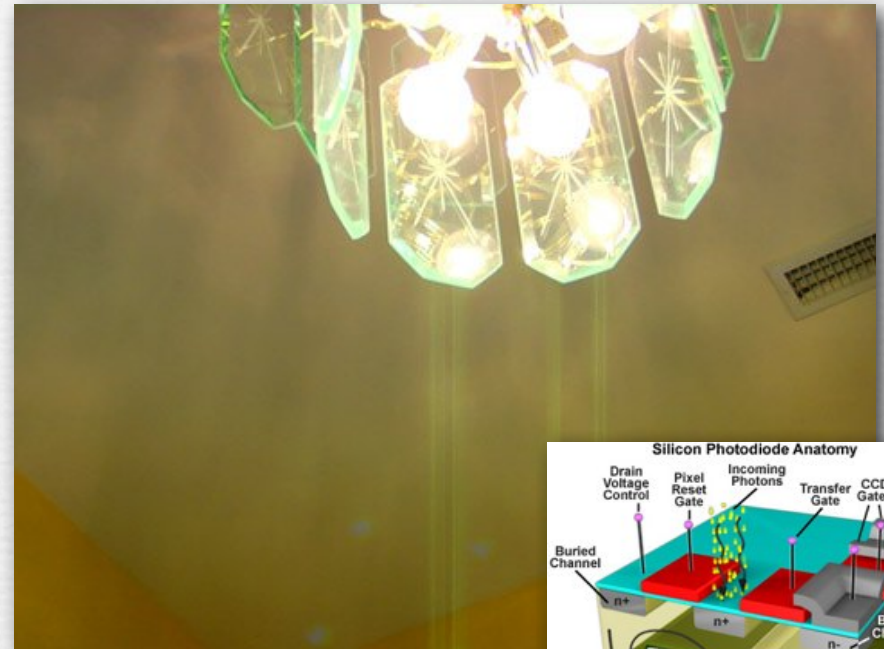

CCD

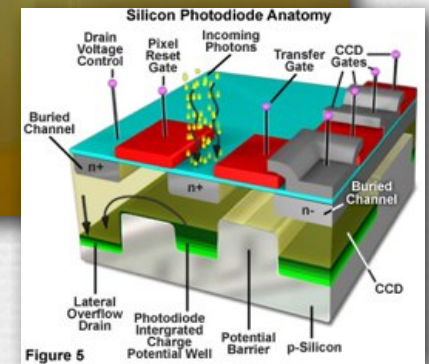
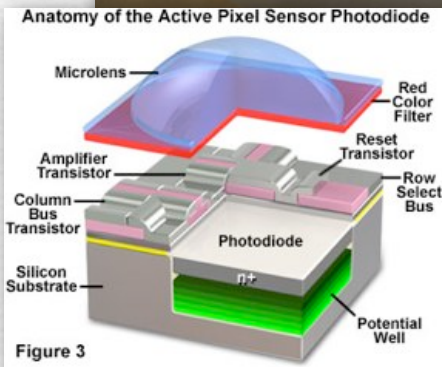

- ◆ side effect of bucket-brigade readout on CCD sensors
  - only happens if pixels saturate
  - doesn't happen on CMOS sensors

# Analog to digital conversion (ADC)

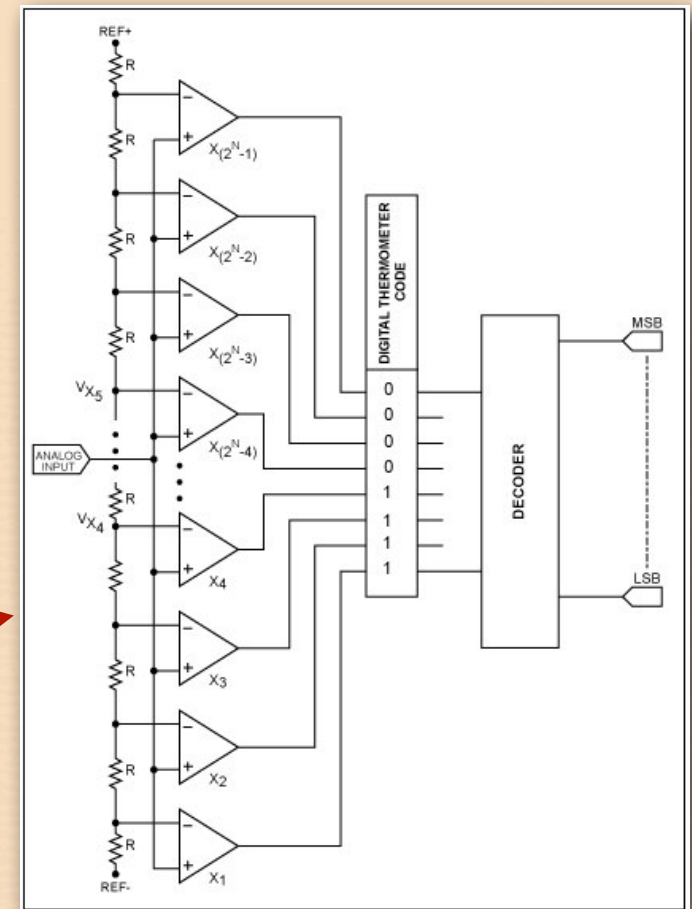
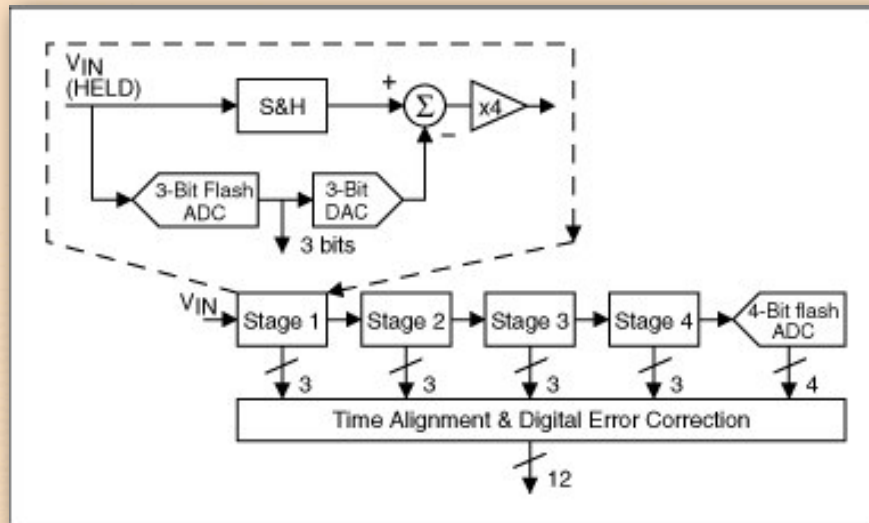

(maxim-ic.com)

- ◆ flash ADC
  - voltage divider → comparators → decoder
  - for n bits requires  $2^n$  comparators
- ◆ pipelined ADC
  - 3-bit ADC → 3-bit DAC → compute residual →  $4\times$  → repeat
  - longer latency, but high throughput
  - some new sensors use an ADC per column



# ADC must output more bits than JPEG stores (contents of whiteboard)

---

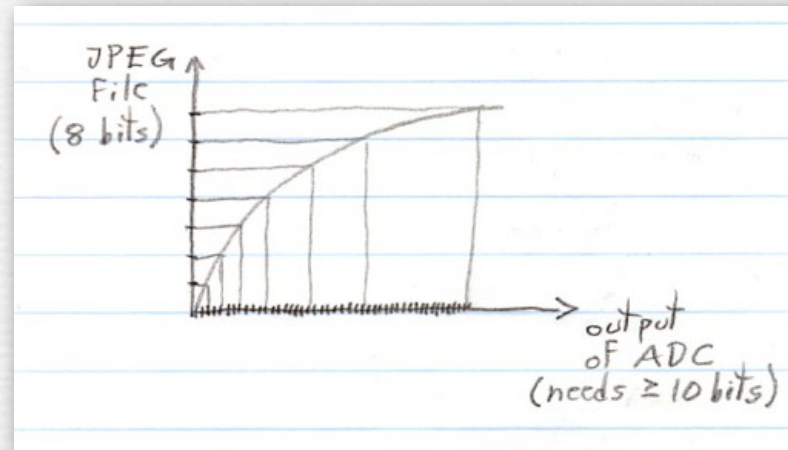

- ◆ converting from analog-to-digital converter (ADC) values (as stored in a RAW file) to the values stored in a JPEG file includes a *tone mapping*; as introduced in the exposure metering lecture, this mapping is typically non-linear and includes a step called *gamma correction*, which has the form  $\text{output} = \text{input}^\gamma$  ( $0.0 \leq \text{input} \leq 1.0$ )
- ◆ since JPEG files only store 8 bits/pixel for each color component, in order for a scene consisting of a smooth gray ramp to fill each of these 256 buckets, the camera's ADC needs to output  $\geq \sim 10$  bits; otherwise, dark parts of the ramp will exhibit banding after applying gamma correction and requantizing (integerizing)

# Fill factor

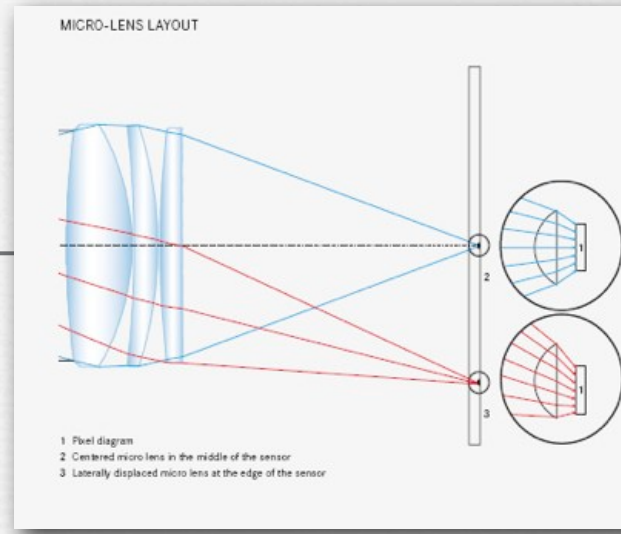

Leica M9  
(digital full-frame)

shifted microlenses on M9

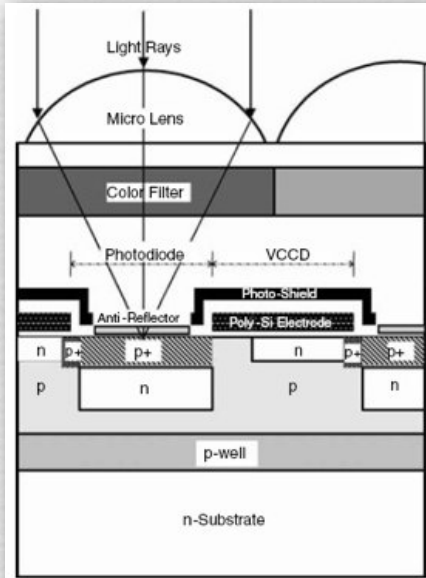

on a CCD sensor

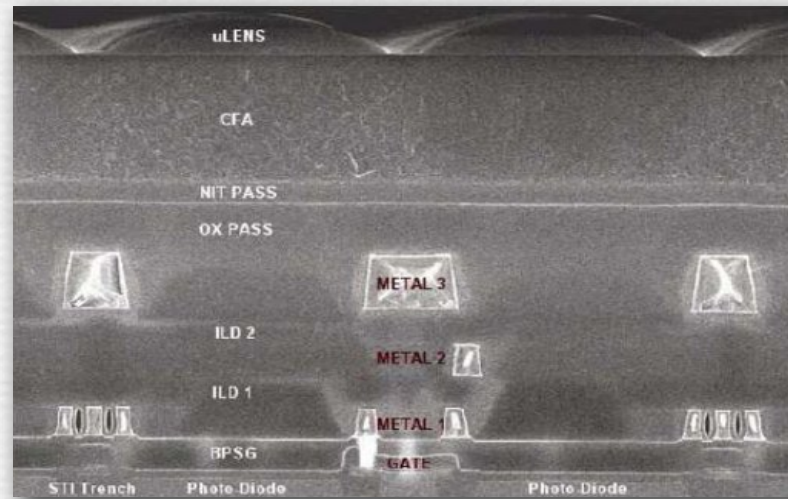

on a (front-illuminated) CMOS sensor

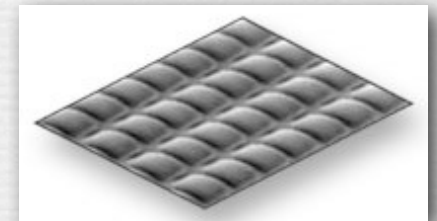

oblique view  
of microlenses

- ◆ fraction of sensor surface available to collect photons
  - can be improved using per-pixel microlenses



# Spatio-temporal prefiltering in photography

---

- ◆ integrating light over an area at each pixel site instead of point sampling serves two functions:
  - captures more photons, to improve *dynamic range*
  - convolves the image with a prefilter, to avoid *aliasing*
- ◆ microlenses gather more light and improve the prefilter
  - microlenses ensure that the *spatial prefilter* is a 2D rect of width roughly equal to the pixel spacing
- ◆ integrating light over the exposure time does the same:
  - captures more photons
  - convolves the scene with a *temporal prefilter*, roughly a 1D rect, creating motion blur if the camera or scene moves



# However, a rect is not an ideal pre-filter (contents of whiteboard)

$$\text{rect}(x) = \Pi(x) = \begin{cases} 0 & \text{if } |x| > \frac{1}{2} \\ \frac{1}{2} & \text{if } |x| = \frac{1}{2} \\ 1 & \text{if } |x| < \frac{1}{2} \end{cases}$$

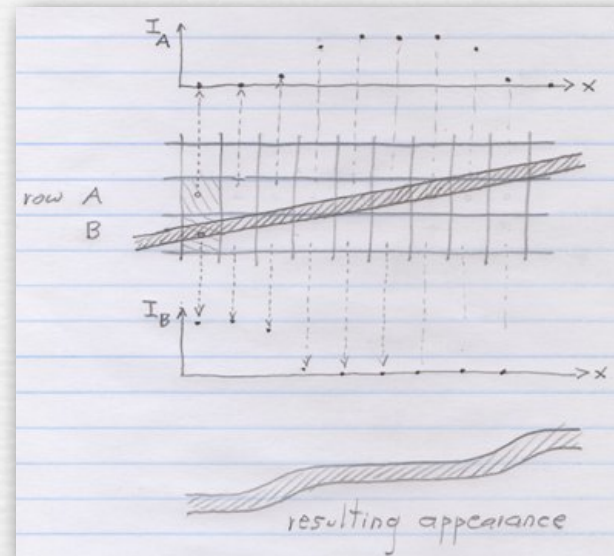
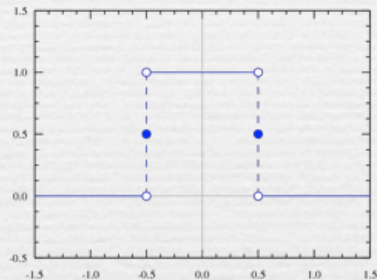

- ◆ as you know, convolving a focused image by a 2D rect (a 1D rect is defined at left above) of width equal to the pixel spacing is equivalent to computing the average intensities in the squares forming each pixel
- ◆ assuming such a 2D rect, a narrow angled stripe object will produce for row A the intensities shown in plot  $I_A$ , rising quickly, staying constant for a while, then dropping; the resulting ropey appearance is aliasing
- ◆ if this were a film and each frame were a 1D rect over time, a small object would appear to move quickly, then pause, then move again

# Antialiasing filters

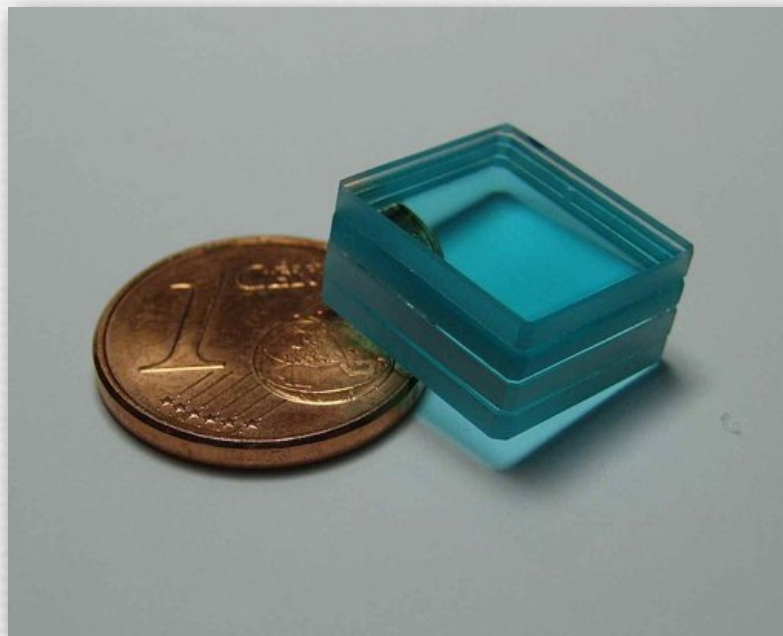

infrared & antialiasing filter



birefringence in a calcite crystal

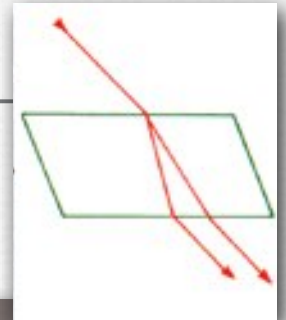

- ◆ improves on non-ideal prefilter, even with microlenses
- ◆ typically two layers of birefringent material
  - splits 1 ray into 4 rays
  - operates like a 4-tap discrete convolution filter kernel



# Removing the antialiasing filter

- ◆ “hot rodding” your digital camera
  - \$450 + shipping

(maxmax.com)

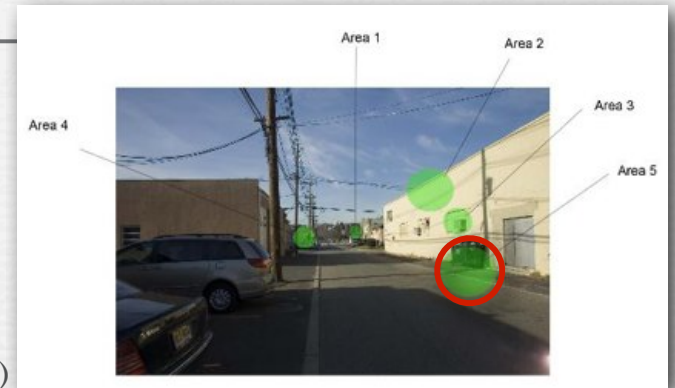

anti-aliasing filter removed



normal



# Removing the antialiasing filter

- ◆ “hot rodding” your digital camera
  - \$450 + shipping

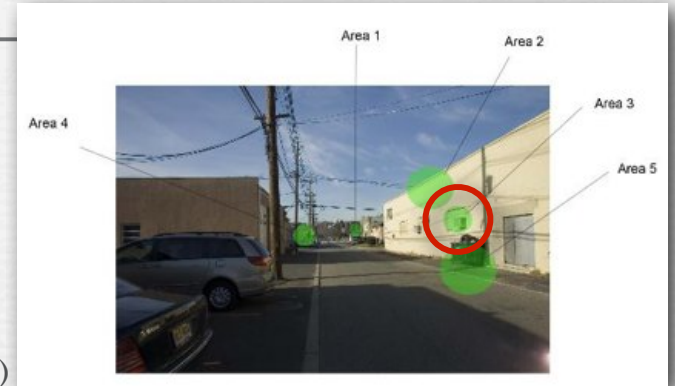

anti-aliasing filter removed

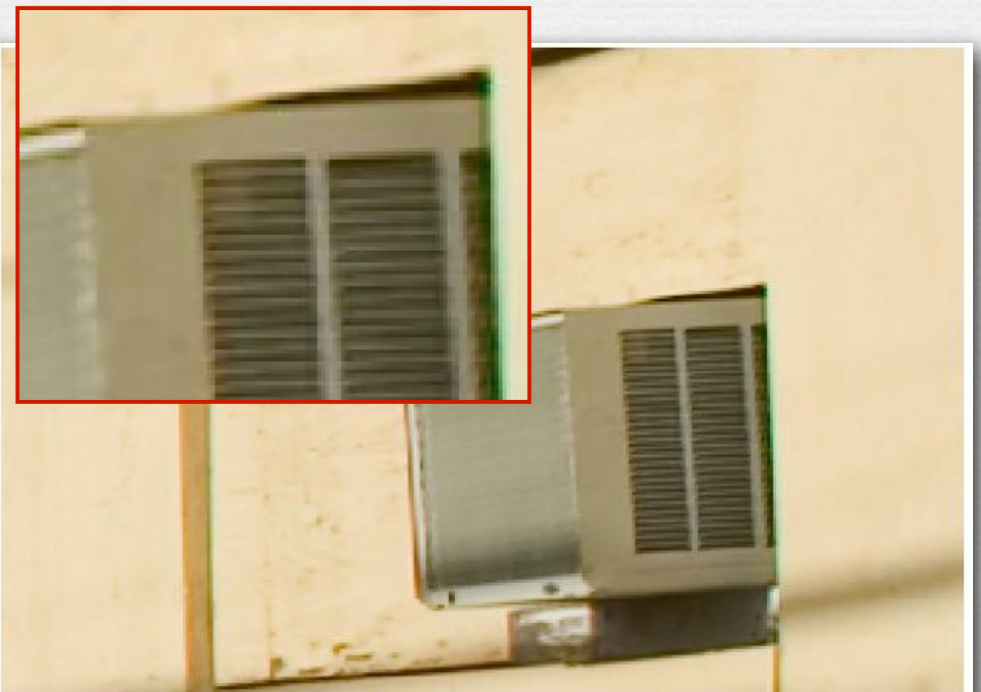

normal

# Recap

---

- ◆ photons strike a sensor and are converted to electrons
  - performance factors include *quantum efficiency* and *pixel size*
- ◆ sensors are typically CCD or CMOS
  - both can suffer *blooming*; only CCDs can suffer *smearing*
- ◆ integrating light over an area serves two functions
  - capturing more photons, to improve *dynamic range*
  - convolving the image with a prefilter, to avoid *aliasing*
  - to ensure that the area spans pixel spacing, use *microlenses*
  - to improve further on the prefilter, use an *antialiasing filter*
- ◆ integrating light over time serves the same two functions
  - captures more photons, but may produce motion blur

## Questions?

# Color

---

- ◆ silicon detects all visible frequencies well
- ◆ can't differentiate wavelengths after photon knocks an electron loose
  - all electrons look alike
- ◆ must select desired frequencies before light reaches photodetector
  - block using a filter, or separate using a prism or dichroic
- ◆ 3 spectral responses is enough
  - a few consumer cameras record 4
- ◆ silicon is also sensitive to near infrared (NIR)
  - most sensors have an IR filter to block it
  - to make a NIR camera, remove this filter



# Historical interlude

---

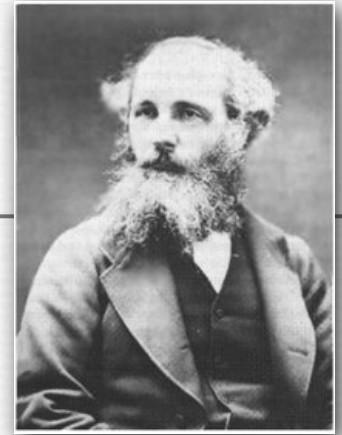

Q. Who made the first color photograph?

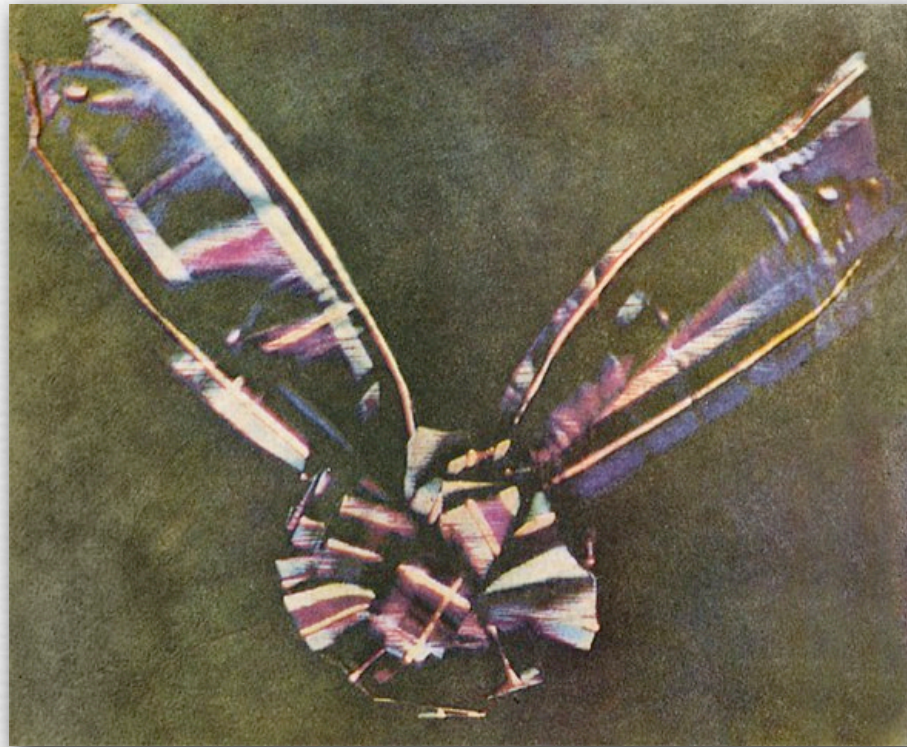

(wikipedia)

- ◆ James Clerk Maxwell, 1861
  - of Maxwell's equations
  - 3 images, shot through filters, then simultaneously projected



# Historical interlude



Q. Who made the first color print?



(wikipedia)

- ◆ Louis Arthur Ducos du Hauron, 1861
  - 3 images, shot through filters, printed with color inks
  - he experimented with RGB and CMY

# Sergey Prokudin-Gorsky

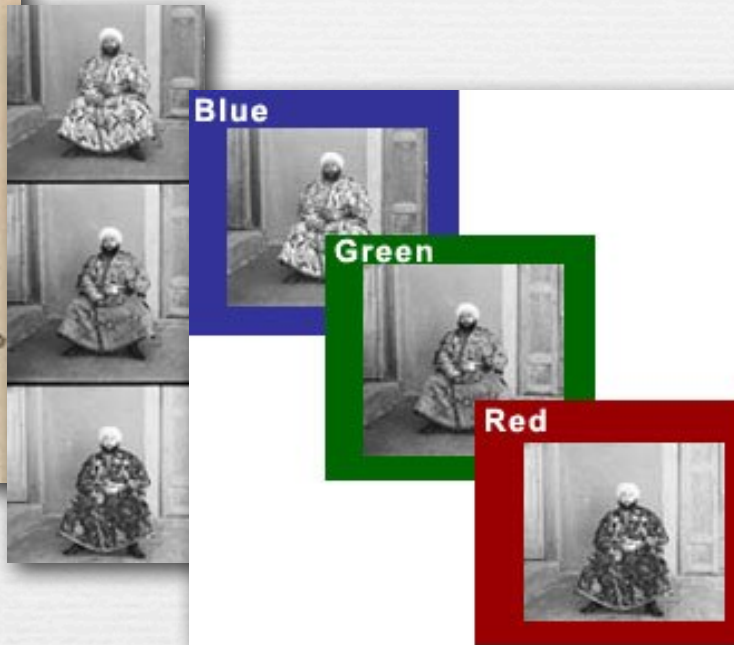
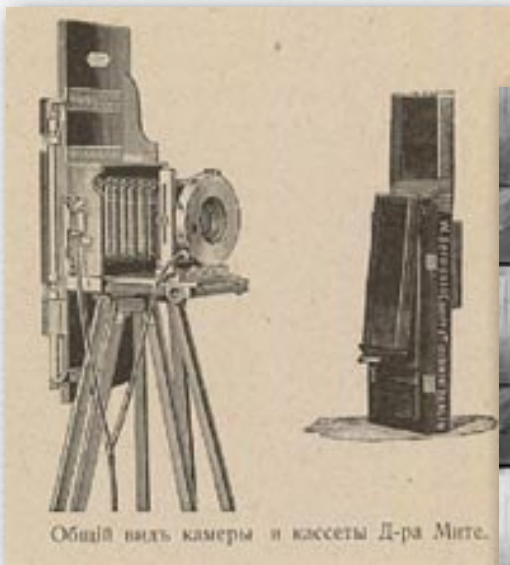

- shot sequentially through R, G, B filters
- simultaneous projection provided good saturation, but available printing technology did not
- digital restoration lets us see them in full glory...





Sergey Prokudin-Gorsky, Alim Khan, emir of Bukhara (1911)





Sergey Prokudin-Gorsky,  
Pinkhus Karlinskii, Supervisor of the Chernigov Floodgate (1919)

# First color movie technology?

---



(wikipedia)

A Visit to the Seaside (1908)

- ◆ George Albert Smith's Kinemacolor, 1906
  - alternating red and green filters, total of 32 fps
  - projected through alternating red and green filters



# Technicolor

---



Toll of the Sea (1922)



Phantom of the Opera (1925)

- ◆ beam splitter leading through 2 filters to two cameras
- ◆ 2 strips of film, cemented together for projection

# Technicolor

---



Disney's Flowers and Trees (1932)



Wizard of Oz (1939)

- ◆ 3 filters, 3 cameras, 3 strips of film
- ◆ better preserved than single-strip color movies of 1960s!



# First consumer color film?

(wikipedia)



Picadilly Circus, 1949

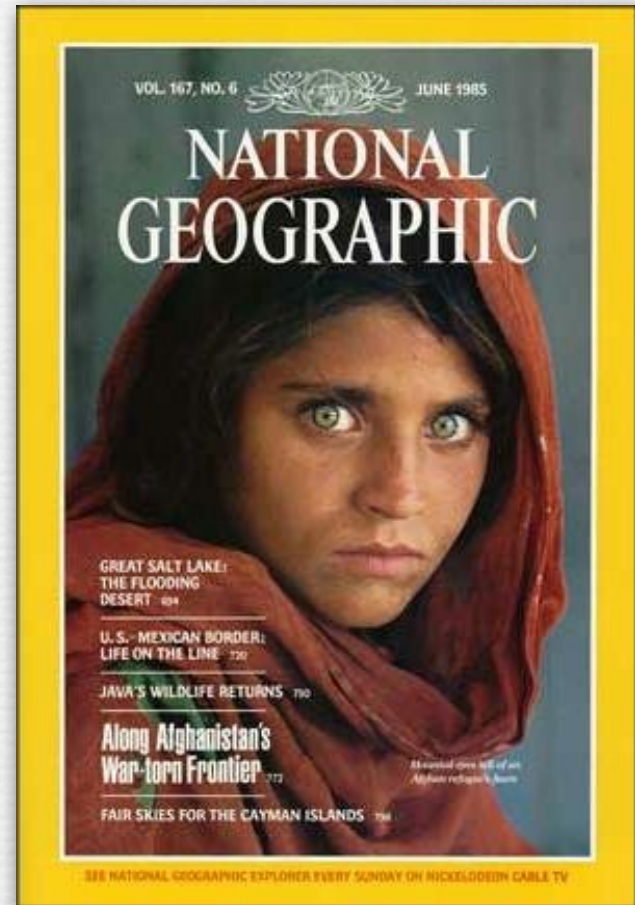

- ◆ Kodachrome, 1935
  - no longer available



# First color television broadcast?

(Beatles in 1964 was in B&W)



started broadcasting in color in 1965

## ◆ competing standards

- U.S. NTSC 525-line, 30fps, interlaced
- Europe PAL 625-line, 25fps, interlaced
- France SECAM 625-line, 25fps, interlaced

# First color television broadcast?

(Beatles in 1964 was in B&W)

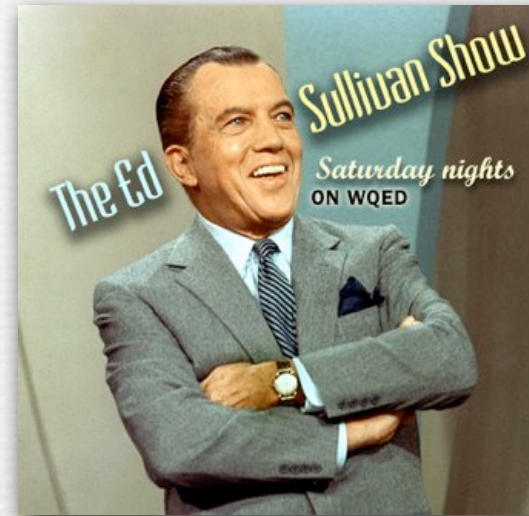

started broadcasting in color in 1965

## ◆ competing standards

- U.S.      NTSC      Never Twice the Same Color
- Europe    PAL      Pale and Lurid
- France    SECAM    Système Electronique Contre les Americains



# Color sensing technologies

---

- ◆ field-sequential - just covered
- ◆ 3-chip
- ◆ vertically stacked
- ◆ color filter arrays



# 3-chip cameras

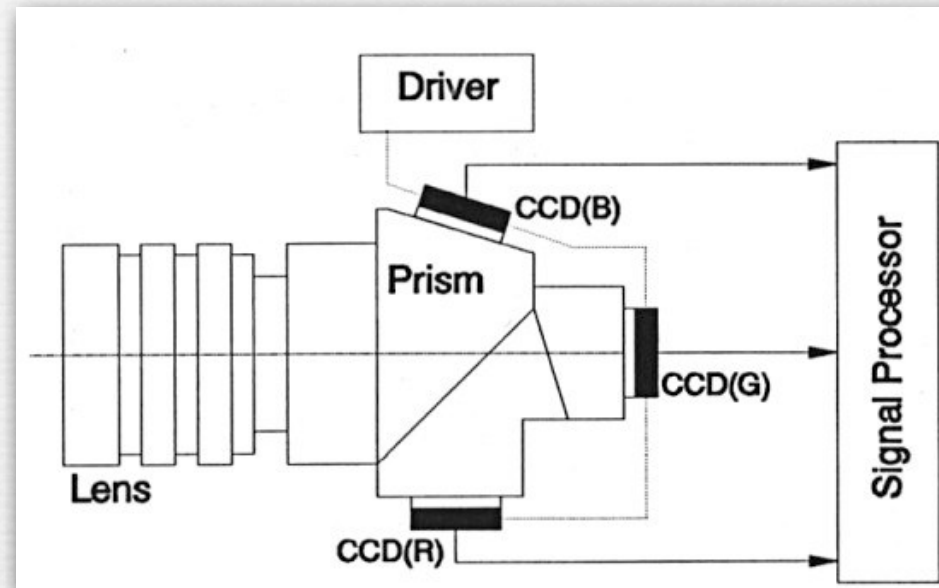

(Theuwissen)

- ◆ high-quality video cameras
- ◆ prism & dichroic mirrors split the image into 3 colors, each routed to a separate sensor (typically CCD)
- ◆ no light loss, as compared to filters (which absorb light)
- ◆ expensive, and complicates lens design

# Foveon stacked sensor

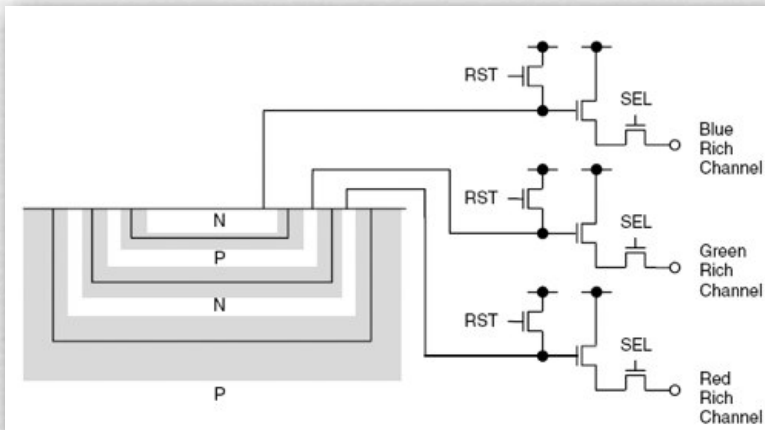

- ◆ longer wavelengths penetrate deeper into silicon, so arrange a set of vertically stacked detectors
  - top gets mostly blue, middle gets green, bottom gets red
  - no control over spectral responses, so requires processing
- ◆ fewer moiré artifacts than color filter arrays + demosaicing
  - but possibly worse noise performance, especially in blue



# Color filter arrays

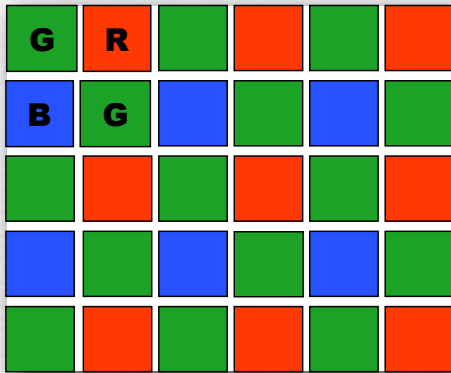

Bayer pattern

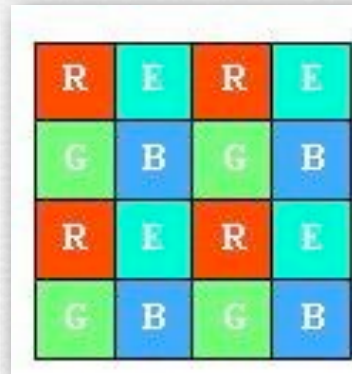

Sony RGB+E  
better color

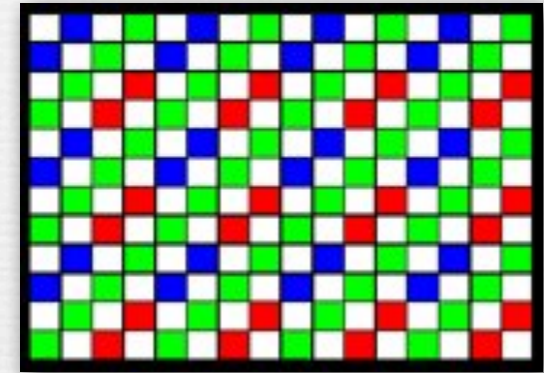

Kodak RGB+C  
more dynamic range

## ◆ Why more green pixels than red or blue?

- because humans are most sensitive in the middle of the visible spectrum
- sensitivity given by the human luminous efficiency curve

(Stone)

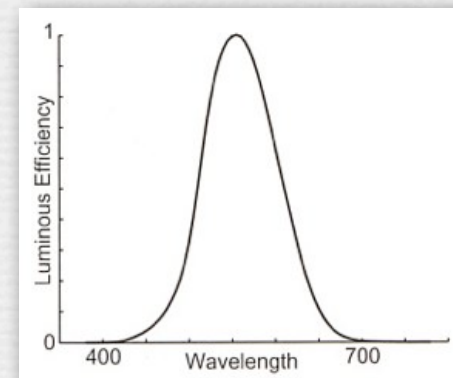

# Example of Bayer mosaic image

---



Small fan at  
Stanford women's  
soccer game

(Canon 1D III)



# Example of Bayer mosaic image

---



# Before demosaicing (dcraw -d)

---

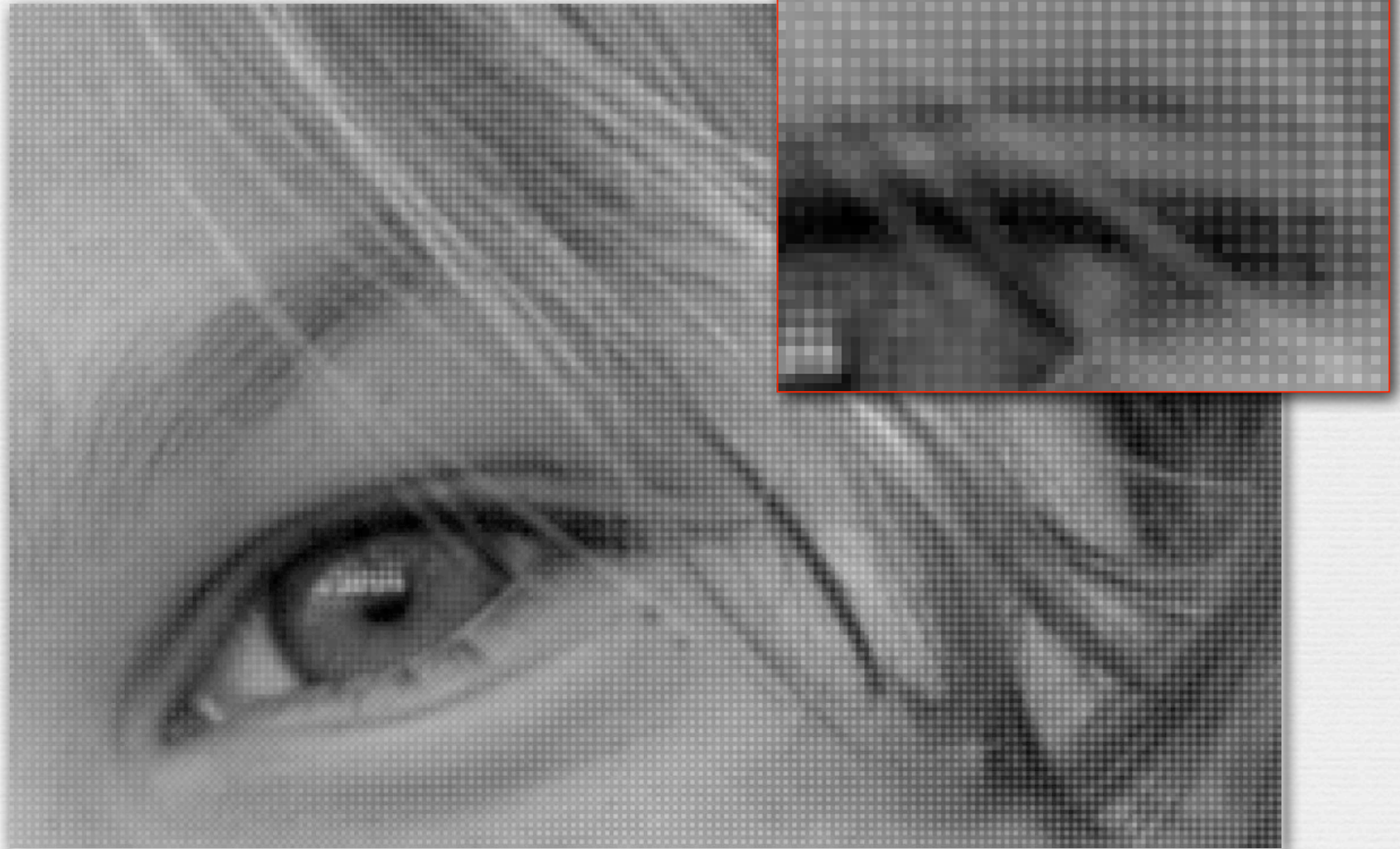



# Example of Bayer mosaic image



# Demosaicing

---

- ◆ linear interpolation
  - average of the 4 nearest neighbors of the same color
- ◆ cameras typically use more complicated scheme
  - try to avoid interpolating across contrasty edges
  - demosaicing is often combined with denoising, sharpening...
- ◆ due to demosaicing,  $2/3$  of your data is “made up”!

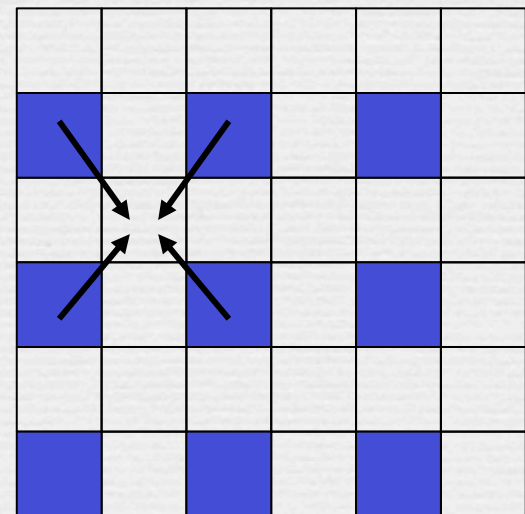
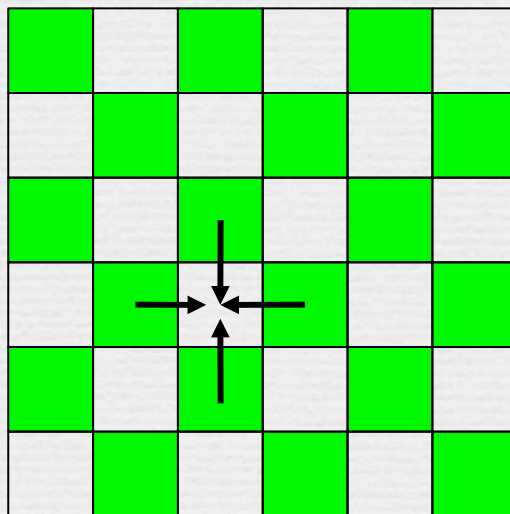
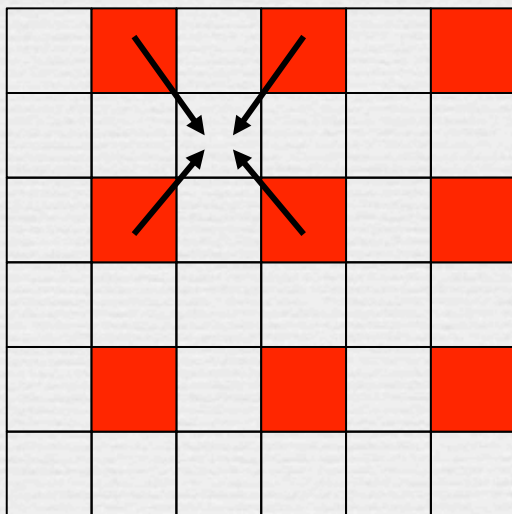



# Recap

---

- ◆ color can only be measured by selecting certain light frequencies to reach certain sensor sites or layers
  - selection can employ *filters* or *dichroics* or *penetration depth*
- ◆ measuring color requires making a tradeoff
  - *field sequential* cameras trade off capture duration
  - *3-chip* cameras trade off weight and expense
  - *vertically stacked* sensors (Foveon) trade off noise (in red)
  - *color filter array* (e.g. Bayer) trades off spatial resolution

Questions?

# Slide credits

---

- ◆ Brian Curless
- ◆ Eddy Talvala
- ◆ Abbas El Gamal

◆ Theuwissen A., *Solid-State Imaging with Charge-Coupled Devices*, Kluwer Academic Publishers, 1995.